

WARNING DEATH MAY OCCUR IF TANK IS ENTERED WITHOUT PROPER EQUIPMENT

NOTE: SEE INNER WALL PHOTO ON THE "EXCLUSIVELY AT SKAW'S" PAGE.

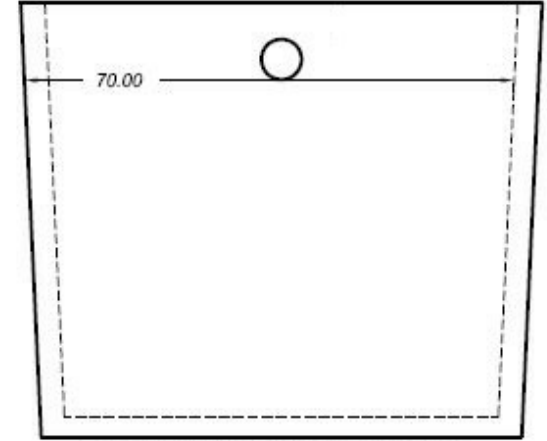

OUTLET END VIEW OF TANK

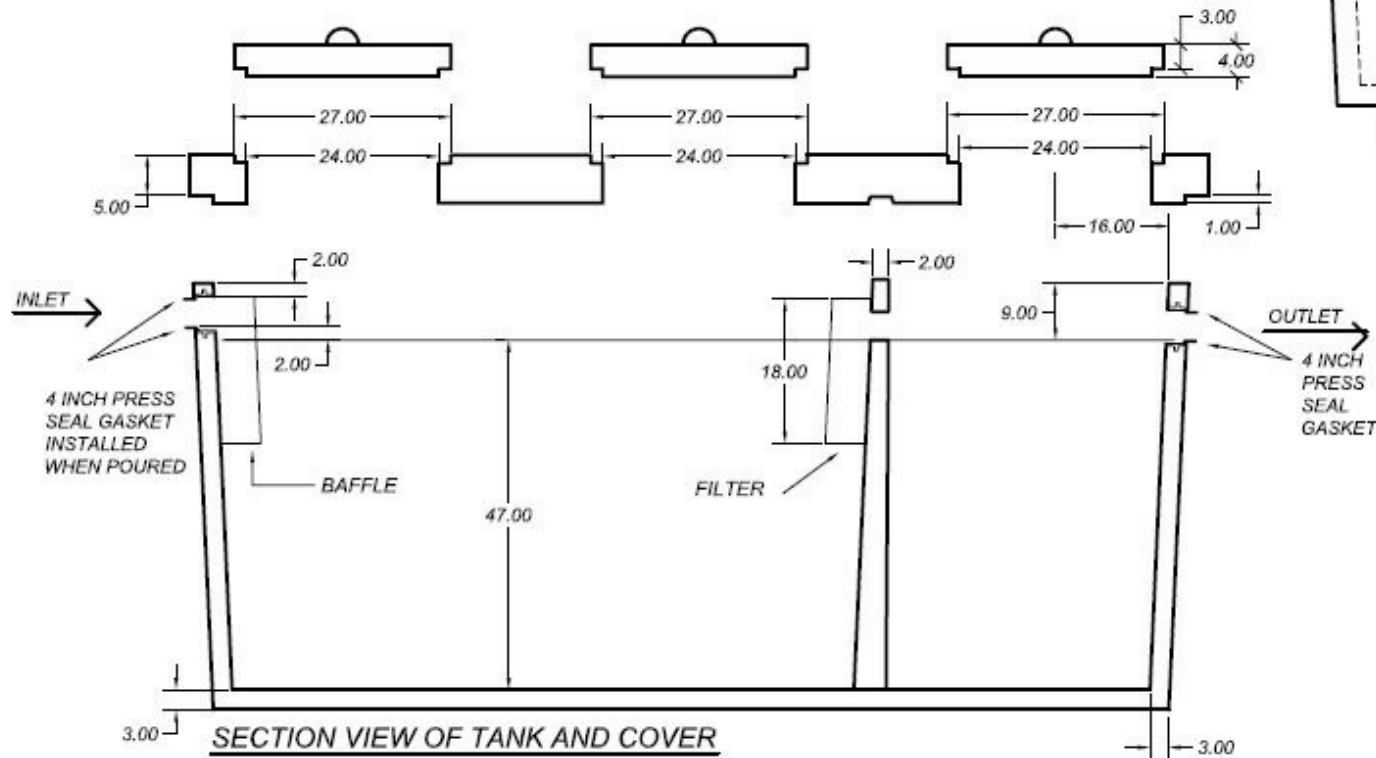

Model Number: **1254/754**

Approved for: SEPTIC/SEPTIC, SEPTIC/PUMP, SEPTIC/SIPHON OR HOLDING

Weight	Inlet Dim.	Outlet Dim.	Liq. Depth	Gal. / In.	Nom. Cap.
16,100 lbs.	52"	50"	47"	16.05	754.35 gal.

SKAW PRE-CAST

26255 105th Street, New Auburn
Wisconsin 54757
www.skawprecast.com

Phone: (715) 967-2277
Toll Free: 1-800-924-8625
Fax: (715) 967-2707

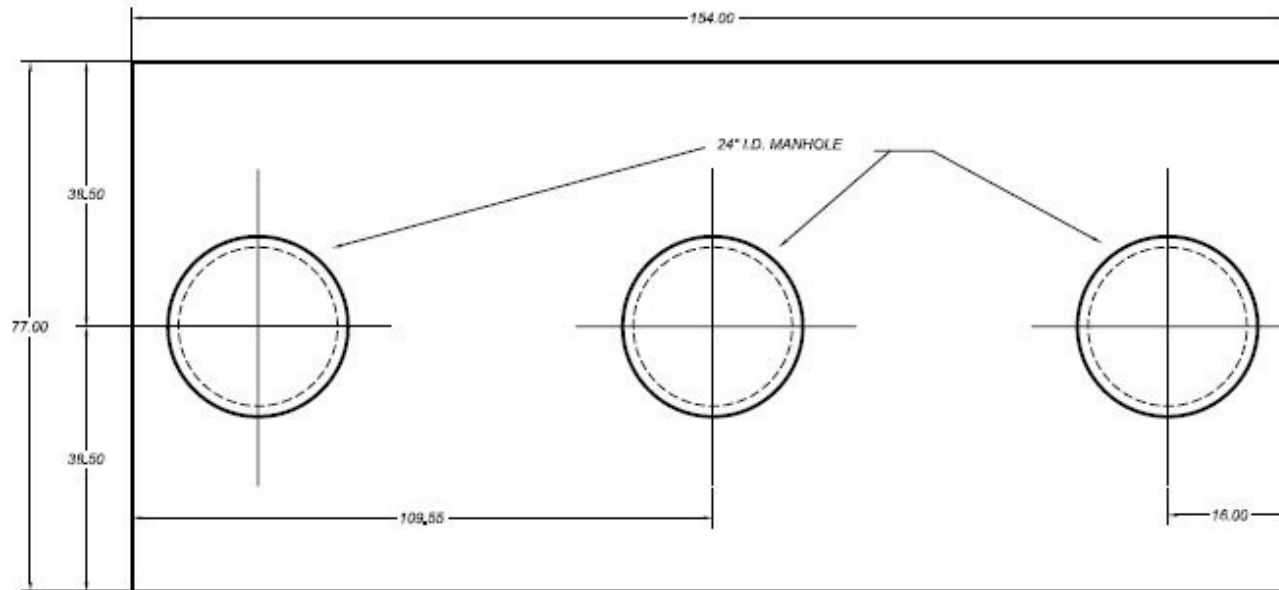

TOP VIEW OF COVER

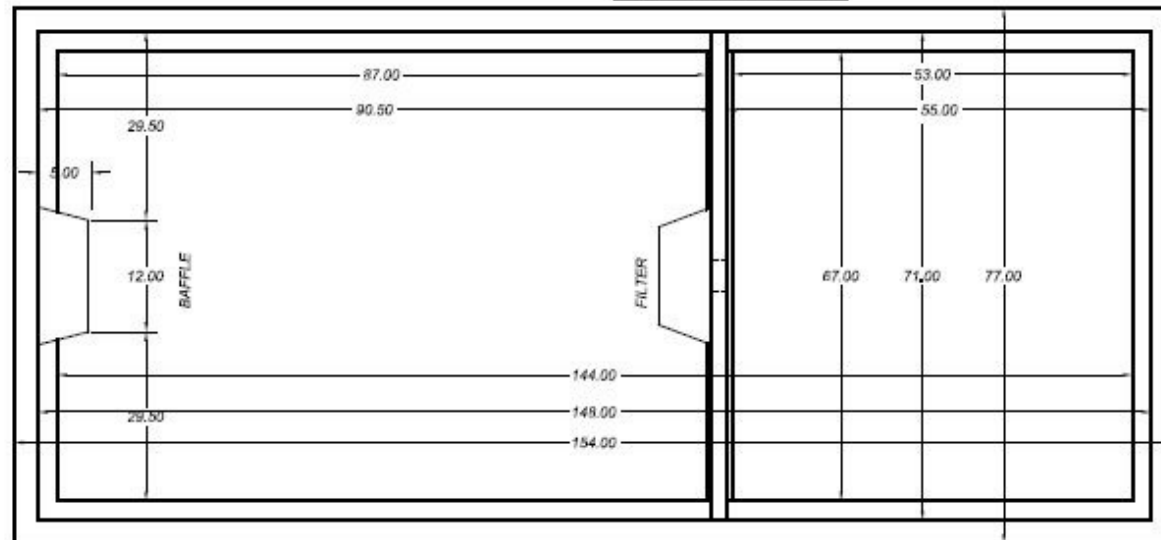

TOP VIEW OF TANK (TAPERED)

Model Number: **1254/754**

Approved for: SEPTIC/SEPTIC, SEPTIC/PUMP, SEPTIC/SIPHON OR HOLDING

Weight	Inlet Dim.	Outlet Dim.	Liq. Depth	Gal. / In.	Nom. Cap.
13,050 lbs.	53"	51"	47"	16.05	754.35 gal.

SKAW PRE-CAST

26255 105th Street, New Auburn
Wisconsin 54757
www.skawprecast.com

Phone: (715) 967-2277
Toll Free: 1-800-924-8625
Fax: (715) 967-2707